

◆ **Technical Data:**

Model: PR-23DC-PTDAI-RT-4G

GENERAL SPECIFICATIONS

Timers: 1024

Counters: 1024

Function Blocks: 1024

Operation temp.: -20°C - 55°C

Storage: -40°C - 70°C

Protection: IP20 (Non-waterproof)

RTC accuracy : MAX ±2S/day

RTC Backup at 25 °C: 20 days

Program and settings Backup: 10 years

Data Power-off retentivity: 10 years

Modify parameters via keypad LCD: yes

Dimensions: 133*90*60 (Unit: mm)

Certificate: CE

Installation: 35-DIN rail or screw for installation

Expansion capacity: 16 modules (PR-E-16)

Password protection: 4-digit number password protection or disable program upload function

Communication interface: 1 RS232 Port (COM0) & 1 RS485 port (COM1 external) available via optional accessory, 1 built-in RS485 (COM2), 1 Ethernet port.

Communication protocol: Modbus RTU/ASCII, Modbus TCP

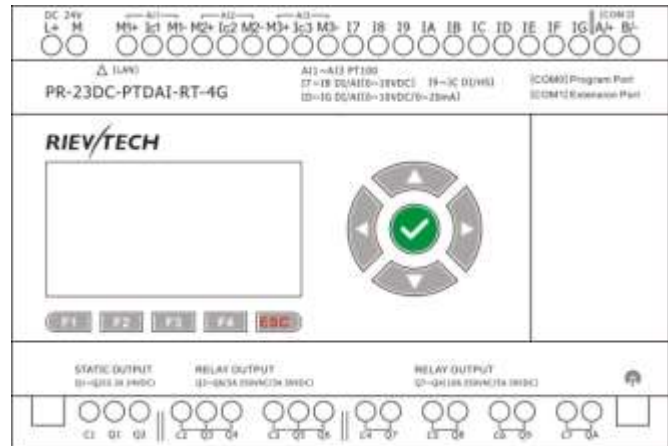

Technical Index

Power supply:	
Nominal voltage	DC 24V
Operating limits	DC 20.4-28.8V
Immunity from micro power cuts	Typ.5 ms
Max. Startup current	Max. 0.3A
Max. absorbed power	10W
Protection against polarity inversions	Yes
Input parameters:	
Input No	13 (AI1-AI3, I7 - IG)
Digital input	10 (I7-IG)
Analogue input	3 PT100(-50...200°C) + 2(I7-I8)(0...10VDC) +4(ID-IG)(0...20mA OR 0...10V DC)
PT100 inputs (AI1-AI3)	
Analog input	3 channels PT100
Resolution	0.3°C
Measuring range	-50°C to +200°C

Cable length	10m max. shielded and twisted
Digital input and analog inputs (0...10V)10bits (I7-I8)	
Inputs used as digital inputs(I7-I8)	
Input voltage	DC0-28.8V
Input signal0	< 5V DC; <0.08mA
Input signal1	> 8 V DC;>0.12mA
Input current	0.16mA @ 10.8V dc 0.18mA @ 12.0 V dc 0.34mA @ 24 V dc 0.41mA @ 28.8 V dc
Response time	0 to 1 : Typ. 10.5 ms ; 1 to 0 : Typ. 1.5 ms
Maximum counting frequency	Typ.: 4 HZ
Sensor type	Contact or 3-wire PNP
Input type	Resistive
Isolation between power supply and inputs	None
Isolation between inputs	None
Inputs used as analog inputs(0..10V)(I7-I8)	
Measurement range	DC 0---10V
Input impedance	Min, 24KΩ; Max. 72KΩ
Input voltage	28.8 V DC max
Resolution	10bit ,0.01V
Accuracy at 25 °C	± (Max.0.02)V
Accuracy at 55 °C	± (Max.0.04)V
Isolation between analog channel and power supply	None
Cable length	10 m max. shielded and twisted
Digital and high speed inputs(I9--IC)	
Digital inputs(I9-IC)	
Input voltage	DC0-28.8V
Input signal0	< 5V DC; <1mA
Input signal1	> 8 V DC;>1.6mA
Input current	2.1mA @ 10.8V dc 2.3mA @ 12.0 V dc 4.6 mA @ 24 V dc 5.5 mA @ 28.8 V dc
Response time	0 to 1 : <1 ms ; 1 to 0 : <1 ms
High speed inputs(I9-IC)	
Maximum counting frequency	60kHz(I9--IC)
Digital and analog(0--10V)&analog(0...20mA)(ID-IG)	
Inputs used as digital inputs(ID-IG)	
Input voltage	DC0-28.8V
Input signal0	< 5V DC; <0.08mA

Input signal1	> 8 V DC;>0.12mA
Input current	0.16mA @ 10.8V dc 0.18mA @ 12.0 V dc 0.34mA @ 24 V dc 0.41mA @ 28.8 V dc
Response time	0 to 1 : Typ. 10.5 ms ; 1 to 0 : Typ. 1.5 ms
Maximum counting frequency	Typ.: 4 HZ
Sensor type	Contact or 3-wire PNP
Input type	Resistive
Isolation between power supply and inputs	None
Isolation between inputs	None
Inputs used as analog inputs(0..10V)(ID-IG)	
Measurement range	DC 0---10V
Input impedance	Min, 24K Ω ; Max. 72K Ω
Input voltage	28.8 V DC max
Resolution	10bit ,0.01V
Accuracy at 25 °C	\pm (Max.0.02)V
Accuracy at 55 °C	\pm (Max.0.04)V
Isolation between analog channel and power supply	None
Cable length	10 m max. shielded and twisted
Input signal0	< 5V DC;<0.08mA
Input signal1	> 8 V DC;>0.12mA
Input current	0.16mA @ 10.8V dc 0.18mA @ 12.0 V dc 0.34mA @ 24 V dc 0.41mA @ 28.8 V dc
Response time	0 to 1 : Typ. 10.5 ms ; 1 to 0 : Typ. 1.5 ms
Sensor type	Contact or 3-wire PNP
Input type	Resistive
Isolation between power supply and inputs	None
Isolation between inputs	None
Inputs used as analog inputs(0..20mA)(ID-IG)	
Analogue signal	0/4....20mA current
Input impedance	260 Ω
Resolution	0.02mA
Accuracy at 25 °C	0.05mA
Cycle time for analog value generation	Typ. 50 ms
Protection against polarity inversions	yes
Overvoltage protection	Yes, if the input voltage is >6.5V, this one is automatically switched on 0--10V configuration
Isolation between power supply and inputs	No
Cable length	<=30M with shielded twisted cable(sensor not isolated)

Output	
Digital/Transistor output(PNP) - Q1,Q2	
Breaking voltage	DC 5--30V
Nominal voltage	≤ Supply voltage
Nominal current	Max. 0.3 A per channel
Max. breaking current	0.65 A
Voltage drop	< 2 V for I = 0.3 A (at state 1)
Response time	Make ≤ 1 ms Release ≤ 1 ms
Frequency (Hz)	resistive load : 10 Hz inductive load : 0.5 Hz
Built-in protections	Against overloads and short-circuits: No Against overvoltages (*): No
Galvanic isolation	None
PWM frequency	10K HZ
PWM cyclic ratio	0 to 100 %
PWM accuracy at 120Hz	< 0.5 % (20 % → 80 %) load at 10 mA
Max. Breaking current PWM	50 mA
Max. cable length PWM	20m
5A Relay 4 outputs from Q3 to Q6	
Max. breaking voltage	CE:AC 250 V/DC 30 V 5A UL:AC 250 V/DC 30 V 3A
Electrical durability Expectancy	10 ⁵ Operations at Rated Resistive Load
Mechanical life	10 ⁷ Operations at No Load condition
Response time	Operate Time: 15 mSec. Max. Release Time: 10 mSec. Max.
Built-in protections	Against short-circuits: None Against overvoltages and overloads: None
10A Relay 4 outputs from Q7 to QA	
Max. breaking voltage	CE:AC 250 V/DC 30 V 10A UL:AC 250 V/DC 28 V 5A
Max. Allowable Power Force	1250VA
Electrical durability Expectancy	10 ⁵ Operations at Rated Resistive Load
Mechanical life	10 ⁷ Operations at No Load condition
Response time	Operate Time: 15 mSec. Max. Release Time: 10 mSec. Max.
Built-in protections	Against short-circuits: None Against overvoltages and overloads: None
Communication ports parameters:	
COM0_TTL port	Can be used as program port with PR-RS232&PR-USB; Also can be convert to RS232 port with PR-RS232 Can be convert to RS485 port with PRO-RS485

	Note:Need move away the expand cover to use it Can be used as modbus master or slave
Built-in RS485 COM2	1 built-in RS485 port (Terminal A+,B-) Can be used as modbus master or slave
Ext RS485 COM1	Need use with PR-E-RS485 module Can be used as modbus master or slave
Ethernet port:	Built-In(10M/100M), 1.Can be used as program or communication 2.Can be used as modbus master or slave
Monitoring webserver page	Yes
Xlogic<--->Xlogic(by Ethernet)	1 xlogic works as tcp server can connect with 8 tcp client xlogics or other tcp devices.
Xlogic<--->Ethernet/Internet:	1 xlogic works as TCP clients can connect with 8 different tcp servers separately in maximum
GSM parameter	
Type of mobile wireless service	SMS, GPRS
Operating frequency	for LTE transmission:B1/B3/B5/B7/B8/B20 with UMTS transmission:B1/B5/B8 for GSM transmission: 850MHz,900MHz,1800MHz,1900MHz,
Type of mobile network / is supported	GSM, UMTS, LTE
for GPRS transmission / with downlink / maximum	80 kbit/s
for GPRS transmission / with uplink / maximum	40 kbit/s
Other parameter	
Weight	Approx.400g



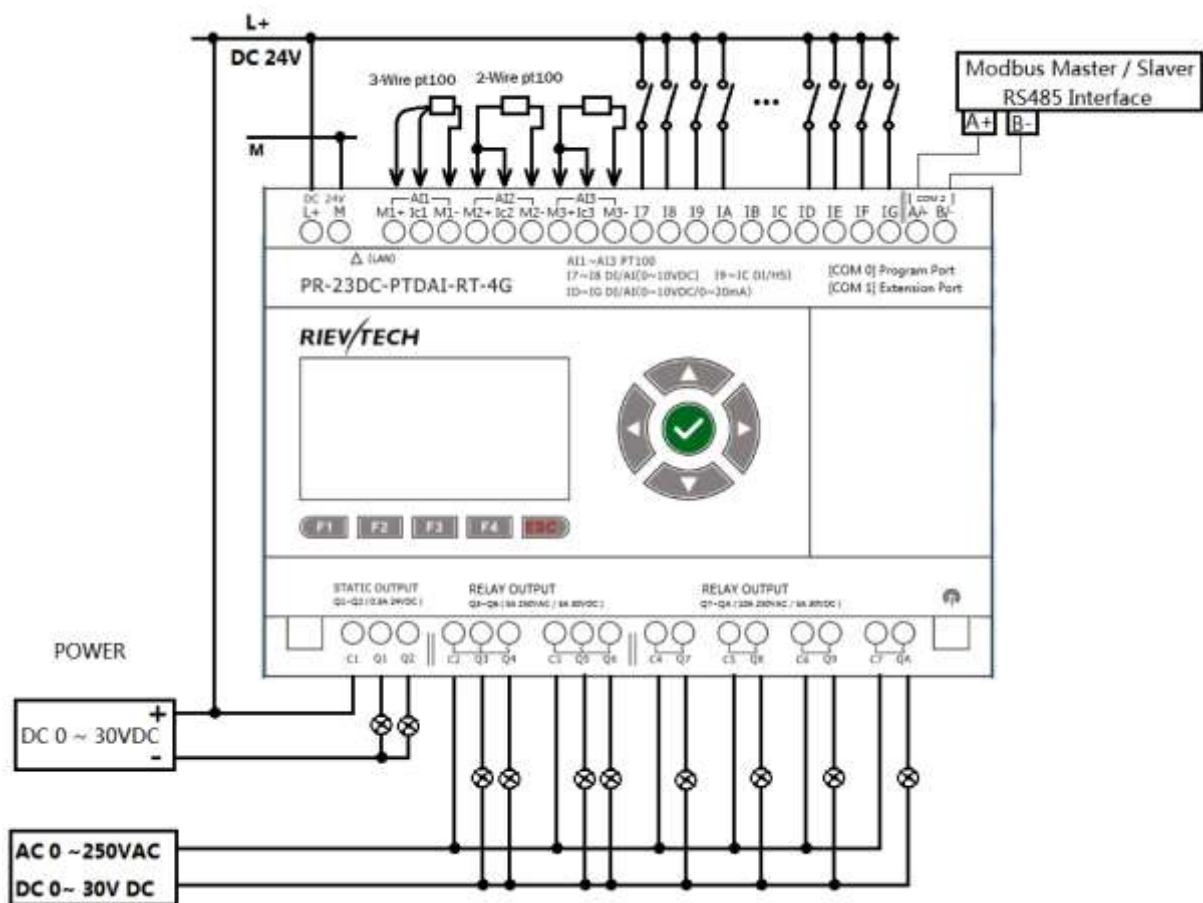
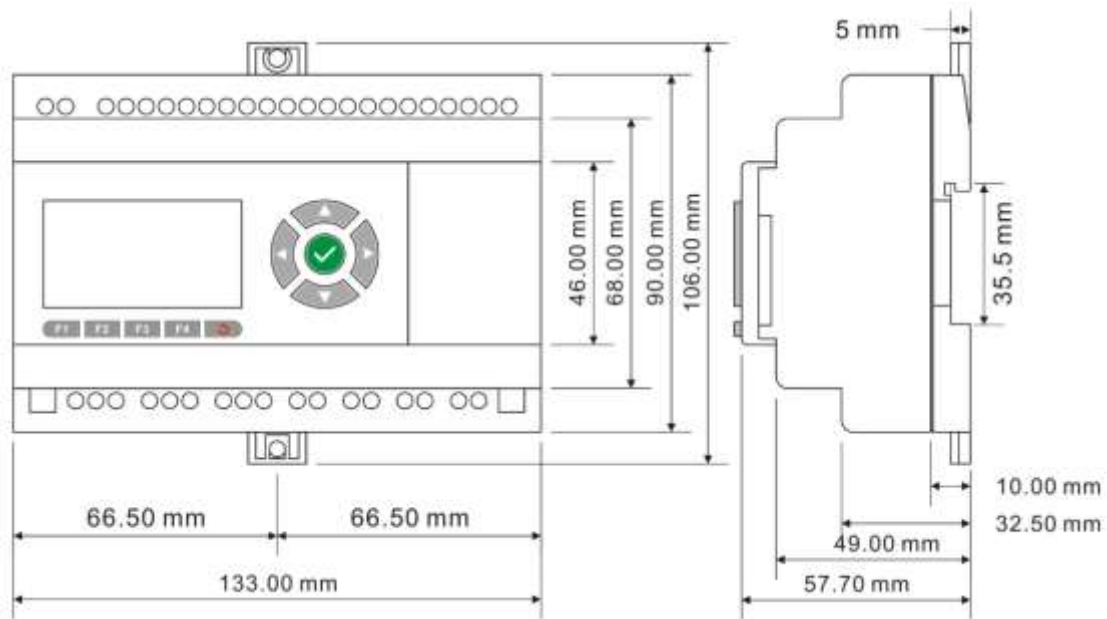

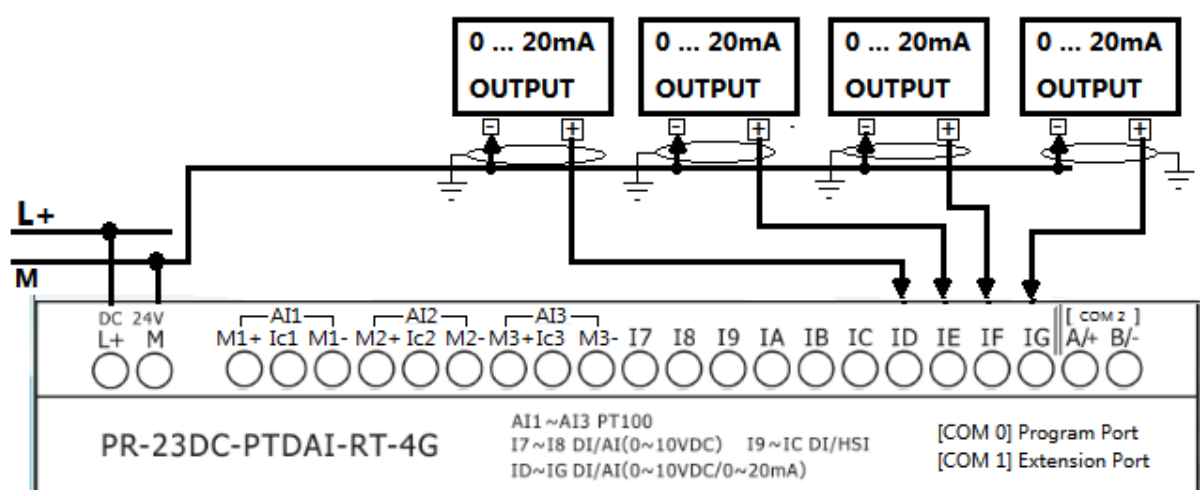
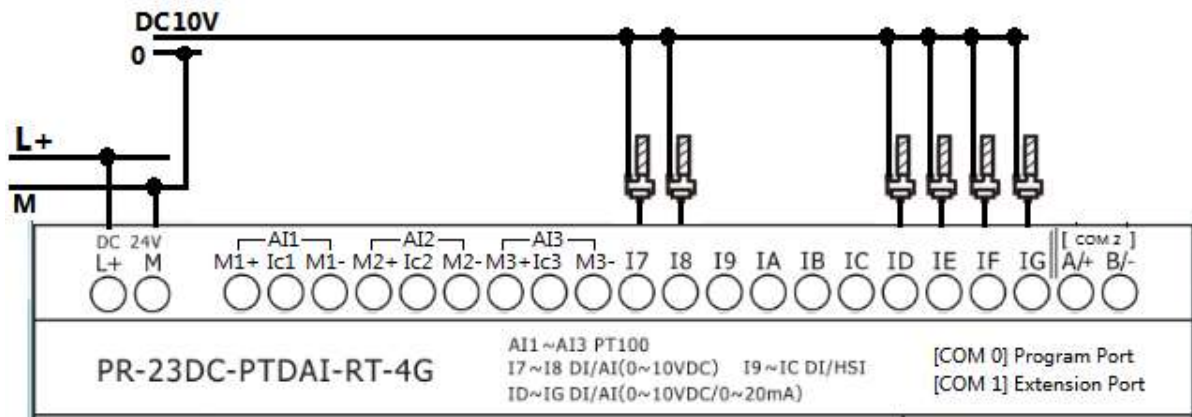





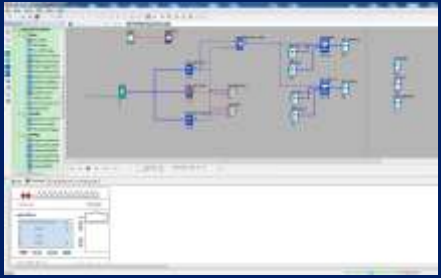

Installation Dimensions & Wiring Dimensions





Program(xlogicsoft) Specification



SYSTEM		Operating System requirements Windows /2000/XP/WIN7/WIN8		Function block 1024	Execution Speed <0.1ms per function	LCD Display 4 lines x 16 characters	Functions Up to 70 function blocks						
BASIC	Timers											a.On-delay; b.Off-delay etc. Up to 12 kind Timers	
	Maximum Number	1024											
	Timing Ranges	10ms--99 h59m											
	Counters											a.Up/down Counter b.Hours Counter c.Frequency Threshold Trigger	
	Maximum Number	1024											
	Highest Count	99999999											
	Resolution	1						a.Weekly Timer b.Yearly Timer					
	RTC												
	Number available	1024											
	Resolution	1 min						a.Digital Flag b.Analog Flag					
	Time span available	Week/year-month-day-hour-min											
	Flags												
	Digital flags	256						a.PI Controller					
	Analog flags	256											
	PI Functions												
	Number available	30						a.Analog Math b.Analog Math Error detection					
	Parameter Ranges	1-32767											
	Analog Math												
Number available	1024						a. Analog Ramp						
Function	ADD, Subtract,Multiply, Divide												
Analog Ramp Function													
Number available	55						a.Analog compactor b.Comparison of 2 values						
Compare Function													
Number available	1024												
Special Functions	HMI Screens						a.Message texts						
	Number available	128											
	Display/Edit	Preset Current value and Free text											
	PWM Functions						a.PWM						
	Number available	1024, (2 fast output for Transistor)											
	Communication Functions						a.Modbus write b.Modbus read						
	Number available	1024(Only CPU works as Master need these 2 blocks, slave does not need)											
	Word/bit data Conversion	Square Boot	Sin/Cos						RS latch relay				
Data-logger Function	Analog watchdog	Analog filter	Average value										

	Pumps Management	Defrost function	Multiplexer	Pulse Relay
	Cam Control	Astronomical clock	Stop watch	Boolean function
Note: 1.Not all program functions are listed in this table i.e. AND,NAND,OR,NOT,NOR,XOR,SHIFT REGISTER,DATA LATCHING RELAY, COMPORT STATUS etc.				